



Kitchen Sinks
& Accessories
Price List
July 2011

If it's not an Oliveri, it's a Compromise.



Oliveri™ Sinks Offer More Than Beauty and Unique Design to the Kitchen.

At the heart of your home is your kitchen. Oliveri sinks transform the kitchen into an efficient gathering place that provides practical work centers, convenience, and beauty. Oliveri sinks are made with heavy gauge type 304 18/10 stainless with the highest percentage of chromium and nickel to produce a deep lustrous finish that is corrosion resistant.

Reasons Why the Oliveri Quality Shines Through

- The Oliveri™ signature represents over 58 years of world class manufacturing in Australia. If it's not an Oliveri, it's a compromise.
- Oliveri sinks have a Lifetime Limited Buyer Warranty. Combining top-grade materials with state of the art production technique, solid construction, and experienced craftsmanship, Oliveri sinks are built to last a lifetime.
- All Oliveri self-rim topmount sinks are designed with a unique rail clipping system. This clipping system allows effortless correct fitting on every spot by simply moving the clip where needed.
- Oliveri sinks are recognized for their extra deep basins and recessed drop ledge, which adds to the sinks' distinctive design.
- All Oliveri self-rim topmount sinks have the unique Oliveri integrated sealing strip. This means when the sink is fitted on a laminate or flat solid surface counter it is water sealed and does not require further sealant.
- Oliveri drain board sinks feature an elegant and unique fan fluted drainer, rounded corners and a double rim design for a more efficient draining and splash protection.
- All Oliveri sinks are sprayed underneath with our patented "Softtone™" for soundproofing and to prevent heat loss.
- All Oliveri sinks are produced in high quality 304 18/10 stainless steel that ensures exceptional appearance for years to come. For extra strength, all bowls are continuous welded into the frame.
- Oliveri sink and food preparation centers offer several different and useful accessory packages. The cutting boards, together with the colanders, fit conveniently into the sink basins. Other accessories include dish-rinsing baskets, drain trays, and basket strainer drains. Appropriate accessories are included with each sink at NO EXTRA CHARGE.
- Most Oliveri sink offerings are available for self-rim top mount or "Down-Undermount™" installation, ideal for counter tops in marble, granite or other solid surface products.

Terms & Conditions

1. All \$100.00 Minimum order on all PO's except for parts.
2. All sales orders shipped under Distributors terms.
3. Prices are subject to change without notice.
4. All Federal, State & Local taxes, when applicable, will be added.
Buyer shall provide Seller with appropriate exemption certificates.
5. If there is visible damage to the box, claims against breakage and/or shortages must be made at the time of receipt against the carrier.
6. Concealed damage must be reported within 72 hours of receipt of merchandise to point of shipment.
7. Shortages must be reported within 48 hours of receipt of merchandise.
8. All shipments are freight on board from Oliveri distributor. Freight allowance, if any, is subject to current sellers shipping terms. Freight allowance is not authorized for display materials.

Return Goods Policy

1. All returns must have a Returned Goods Authorization (RGA).
2. Oliveri distributor must approve all RGA's.
3. A copy of the invoice and reason for return is required to establish a RGA.
4. All non-warranty returns are subject to a \$30.00 per carton restocking fee.
5. All items must be returned in the original carton and in saleable condition.
6. All Returns must be made freight prepaid by sender and the sender must assume all responsibility for shipping damages that may occur. If product is received damaged, there will be no credit issued. The Oliveri distributor reserves the right to limit and/or refuse any returns at their discretion.
7. Product considered modified, special order, discontinued, or custom, may not be returned.

Warranty

1. All Oliveri sinks carry Tasman Sinkware's Lifetime Limited Buyer Warranty.
2. Oliveri sinks are warranted free of manufacturing defects.
3. Tasman Sinkware shall at its election, repair, replace, or make appropriate adjustment where Tasman Sinkware inspection discloses any such defects occurring in normal usage. Tasman Sinkware is not responsible for installation costs, or consequential damages.
4. The warranty does not cover product failure caused by abusive treatment, surface scratches, misuse, or damage due to handling or faulty installations. This warranty is extended only to the original consumer purchaser of the product and excludes accessories and attachment products.
5. No additional warranties, express or implied are given. Any implied warranty including one of merchantability or fitness for a particular purpose are excluded.
6. To obtain warranty service, contact Tasman Sinkware either through your dealer or distributor or write to Tasman Sinkware US office

Tasman Sinkware North America, Inc.
1230 Railroad Street
Corona CA 92882
Email: northamerica@oliverisinks.com

Notes

Oliveri™ is a Registered Trademark of Tasman Sinkware Pty Ltd.
Softtone™ is a Registered Trademark of Tasman Sinkware Pty Ltd.
The unauthorized use of these trademarks is expressly forbidden except by prior agreement.



www.oliverisinks.com

CONTENTS

1100 Series	4
800 Series and Essentials Undermount	7
800 Series Topmount	11
Apron Series	13
Drainboard Series	15
Compact Series	17
Preparation Bar Series	19
Laundry Series	22
Parts and Accessories	26
Product Index	27

1100 series



36 **Cabinet Space**
This icon indicates minimum cabinet space (inches) for the sink base unit to accommodate basins (e.g. 36 = 36 inches)

1130U

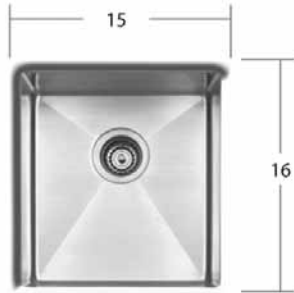

LIST PRICE
\$806

18

OVERALL DIMENSIONS	17 x 18"	432 x 457mm
3/4 BASIN	15 x 16 x 10"	381 x 406 x 254mm
MINIMUM CABINET WIDTH	18"	46cm

INCLUDED ACCESSORIES

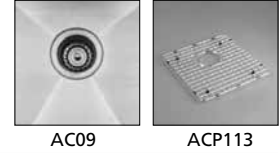

OPTIONAL ACCESSORIES

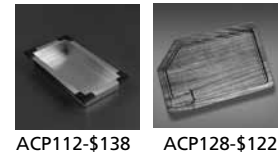

1140U

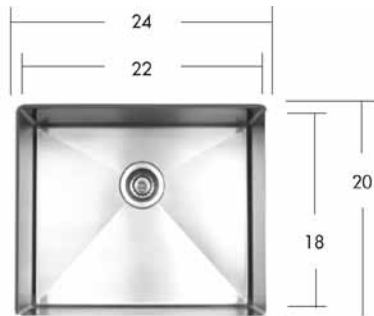

LIST PRICE
\$906

27

OVERALL DIMENSIONS	24 x 20"	610 x 508mm
LARGE BASIN	22 x 18 x 10"	559 x 457 x 254mm
MINIMUM CABINET WIDTH	27"	69cm

INCLUDED ACCESSORIES

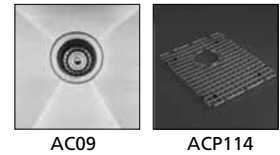

OPTIONAL ACCESSORIES

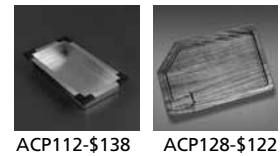

1150U



LIST PRICE
\$876

18

OVERALL DIMENSIONS	17 x 20"	432 x 508mm
STANDARD BASIN	15 x 18 x 10"	381 x 457 x 254mm
MINIMUM CABINET WIDTH	18"	46cm

INCLUDED ACCESSORIES

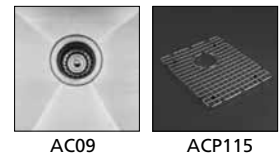

OPTIONAL ACCESSORIES

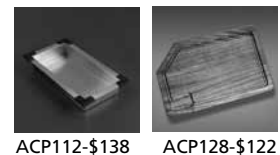

1100 series



36 **Cabinet Space**
This icon indicates minimum cabinet space (inches) for the sink base unit to accommodate basins (e.g. 36 = 36 inches)

1160U



LIST PRICE
\$786

15

OVERALL DIMENSIONS	12 x 18"	305 x 457mm
1/2 BASIN	10 x 16 x 8"	254 x 406 x 203mm
MINIMUM CABINET WIDTH	15"	38cm
INCLUDED ACCESSORIES		



AC09



ACP116

1163U

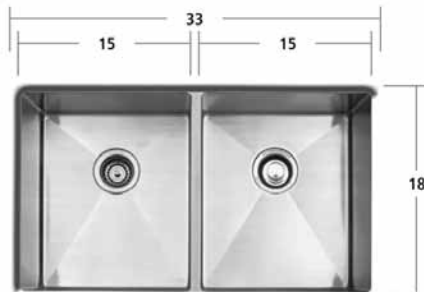

LIST PRICE
\$1898

36

OVERALL DIMENSIONS	33 x 20"	838 x 508mm
STANDARD BASIN	15 x 18 x 10"	381 x 457 x 254mm
MINIMUM CABINET WIDTH	36"	92cm
INCLUDED ACCESSORIES		



AC09 x 2



ACP115 x 2

OPTIONAL ACCESSORIES



ACP112-\$138

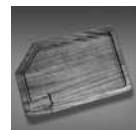

ACP128-\$122

1173U

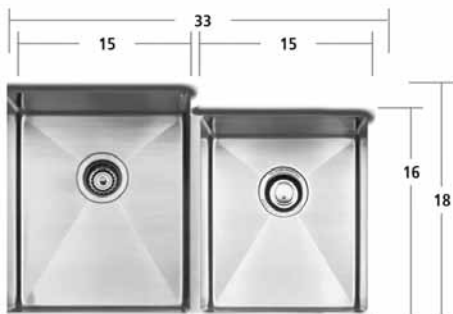

LIST PRICE
\$1865

36

OVERALL DIMENSIONS	33 x 20"	838 x 508mm
STANDARD BASIN	15 x 18 x 10"	381 x 457 x 254mm
3/4 BASIN	15 x 16 x 10"	381 x 406 x 254mm
MINIMUM CABINET WIDTH	36"	92cm
INCLUDED ACCESSORIES		



AC09 x 2



ACP115

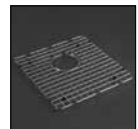

ACP113

OPTIONAL ACCESSORIES



ACP112-\$138

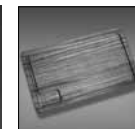

ACP126-\$116

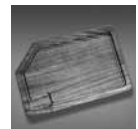

ACP128-\$122

1100 series



16
GAUGE

36 **Cabinet Space**
This icon indicates minimum cabinet space (inches) for the sink base unit to accommodate basins (e.g. 36 = 36 inches)

1183U

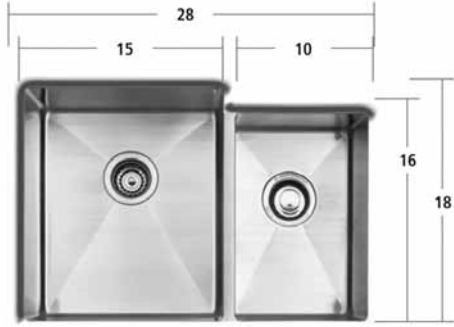

LIST PRICE
\$1875

30

OVERALL DIMENSIONS	28 x 20"	711 x 508mm
STANDARD BASIN	17 x 18 x 10"	432 x 457 x 254mm
1/2 BASIN	10 x 16 x 8"	254 x 406 x 203mm
MINIMUM CABINET WIDTH	30"	76cm

INCLUDED ACCESSORIES

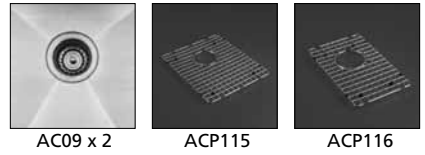

OPTIONAL ACCESSORIES

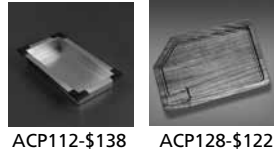

1190U

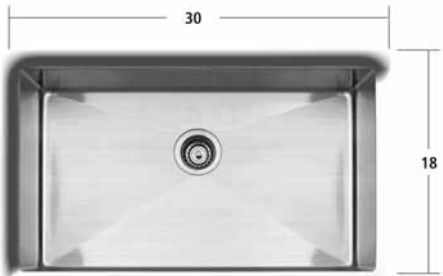

LIST PRICE
\$1246

36

OVERALL DIMENSIONS	32 x 20"	813 x 508mm
TITAN BASIN 2	30 x 18 x 10"	762 x 457 x 254mm
MINIMUM CABINET WIDTH	36"	92cm

INCLUDED ACCESSORIES

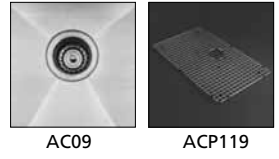

OPTIONAL ACCESSORIES

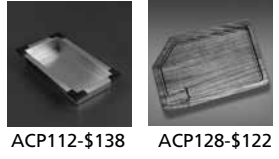

800 series and Essentials undermounts



36 **Cabinet Space**
This icon indicates minimum cabinet space (inches) for the sink base unit to accommodate basins (e.g. 36 = 36 inches)

Essentials series have sound deadening pads but do not have undercoating or accessories included. Some configurations have shallower bowl depths compared to the regular 800 series equivalent.

833U

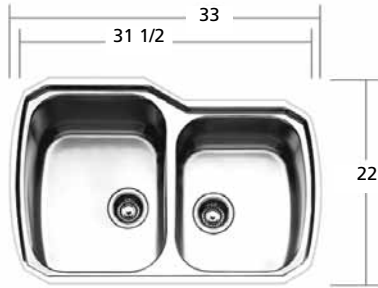

LIST PRICE
\$976

36

OVERALL DIMENSIONS	33 x 22"	840 x 564mm
GOURMET BASIN	14 3/4 x 19 x 10"	375 x 483 x 254mm
MAXI BASIN 1	13 3/4 x 16 1/2 x 8"	350 x 420 x 203mm
MINIMUM CABINET WIDTH	36"	92cm

INCLUDED ACCESSORIES

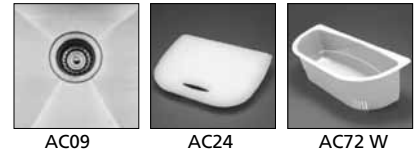

834U

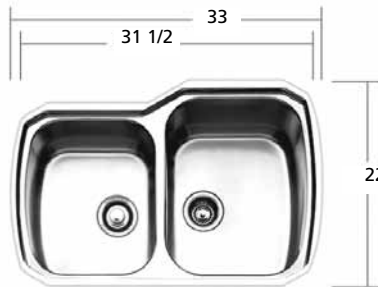

LIST PRICE
\$976

36

OPTIONAL ACCESSORIES

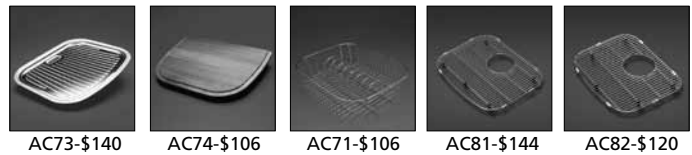

863U

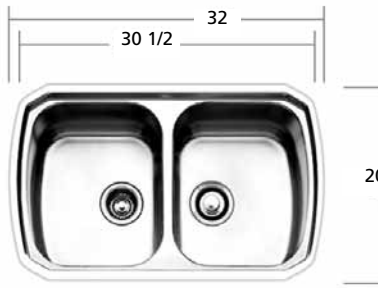

LIST PRICE
\$899

36

OVERALL DIMENSIONS	32 x 20"	813 x 508mm
MAXI BASIN 1	13 3/4 x 16 1/2 x 8"	350 x 420 x 203mm
MINIMUM CABINET WIDTH	36"	92cm

INCLUDED ACCESSORIES

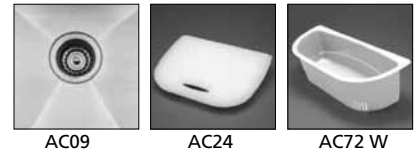

OPTIONAL ACCESSORIES

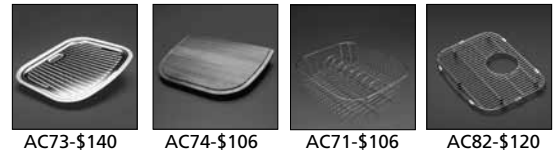

63U Essentials series

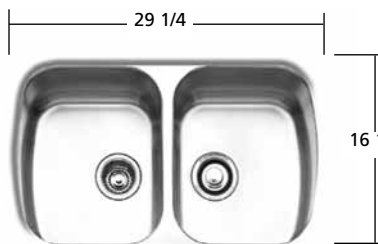

LIST PRICE
\$598

33

OVERALL DIMENSIONS	29 1/4 x 16 1/2"	825 x 525mm
MEDIUM BASIN	12 3/4 x 16 1/2 x 7"	324 x 419 x 178mm
MEDIUM BASIN	12 3/4 x 16 1/2 x 7"	324 x 419 x 178mm
MINIMUM CABINET WIDTH	33"	84cm

OPTIONAL ACCESSORIES

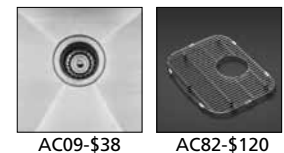

800 series and Essentials undermounts



18
GAUGE

36

Cabinet Space
This icon indicates minimum cabinet space (inches) for the sink base unit to accommodate basins (e.g. 36 = 36 inches)

Essentials series have sound deadening pads but do not have undercoating or accessories included. Some configurations have shallower bowl depths compared to the regular 800 series equivalent.

873U

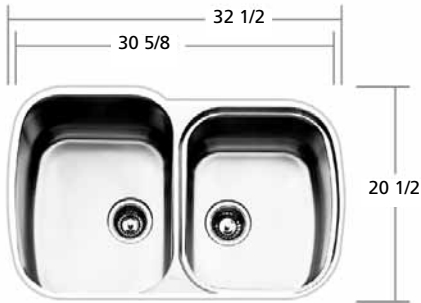

LIST PRICE
\$976

36

OVERALL DIMENSIONS	32 1/2 x 20 1/2"	825 x 525mm
GOURMET BASIN	14 3/4 x 19 x 9 1/2"	375 x 483 x 241mm
MAXI BASIN 1	13 3/4 x 16 1/2 x 8"	350 x 420 x 203mm
MINIMUM CABINET WIDTH	36"	92cm

INCLUDED ACCESSORIES

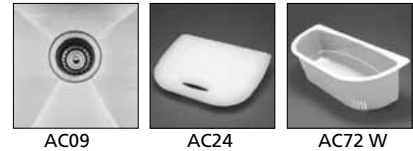

OPTIONAL ACCESSORIES

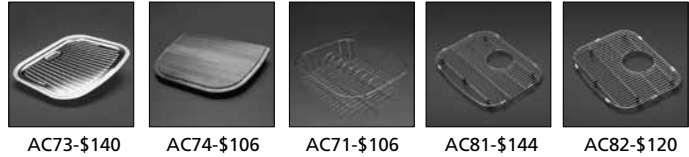

73U Essentials series

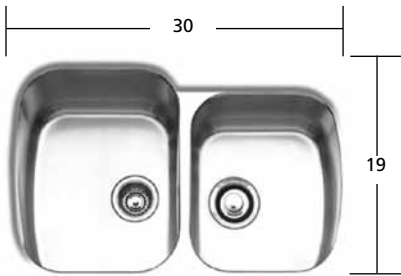

LIST PRICE
\$692

33

OVERALL DIMENSIONS	30 x 19"	762 x 483mm
LARGE BASIN	14 3/4 x 19 x 9 1/2"	375 x 483 x 241mm
MEDIUM BASIN	12 3/4 x 16 x 7"	324 x 406 x 178mm
MINIMUM CABINET WIDTH	33"	84cm

OPTIONAL ACCESSORIES

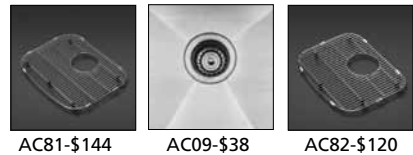

874U

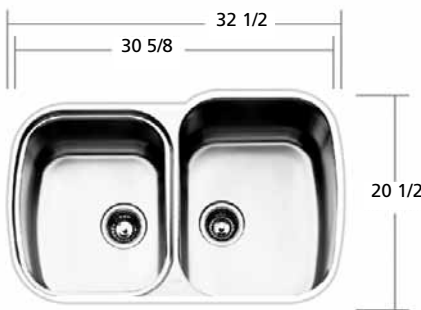

LIST PRICE
\$976

36

OVERALL DIMENSIONS	32 1/2 x 20 1/2"	825 x 525mm
GOURMET BASIN	14 3/4 x 19 x 9 1/2"	375 x 483 x 241mm
MAXI BASIN 1	13 3/4 x 16 1/2 x 8"	350 x 420 x 203mm
MINIMUM CABINET WIDTH	36"	92cm

INCLUDED ACCESSORIES

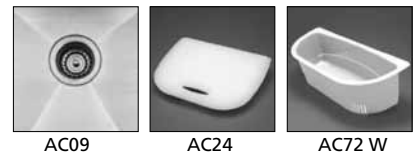

OPTIONAL ACCESSORIES

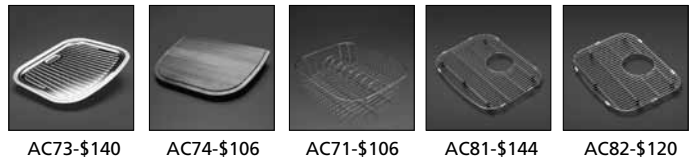

74U Essentials series

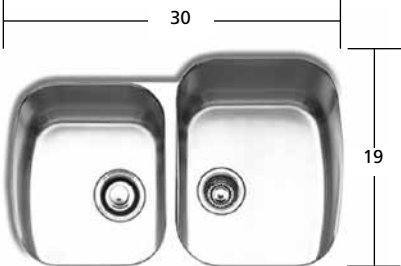

LIST PRICE
\$692

33

OVERALL DIMENSIONS	30 x 19"	762 x 483mm
LARGE BASIN	14 3/4 x 19 x 9 1/2"	375 x 483 x 241mm
MEDIUM BASIN	12 3/4 x 16 x 7"	324 x 406 x 178mm
MINIMUM CABINET WIDTH	33"	84cm

OPTIONAL ACCESSORIES

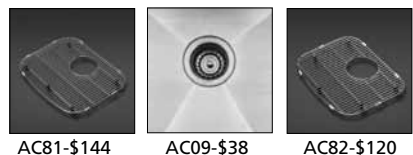

800 series and Essentials undermounts



18
GAUGE

36 Cabinet Space
This icon indicates minimum cabinet space (inches) for the sink base unit to accommodate basins (e.g. 36 = 36 inches)

Essentials series have sound deadening pads but do not have undercoating or accessories included. Some configurations have shallower bowl depths compared to the regular 800 series equivalent.

880U

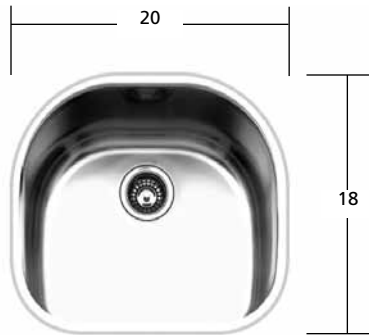

LIST PRICE
\$625

24

OVERALL DIMENSIONS	20 x 18"	508 x 457mm
SUPER BASIN	20 x 18 x 9 1/2"	508 x 457 x 241mm
MINIMUM CABINET WIDTH	24"	61cm
INCLUDED ACCESSORIES		



AC09



AC80

80U Essentials series

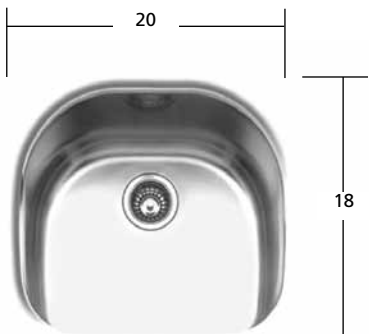

LIST PRICE
\$358

24

OVERALL DIMENSIONS	20 x 18"	508 x 457mm
SUPER BASIN	20 x 18 x 9 1/2"	508 x 457 x 241mm
MINIMUM CABINET WIDTH	24"	61cm
OPTIONAL ACCESSORIES		



AC09-\$38



AC80-\$166

883U

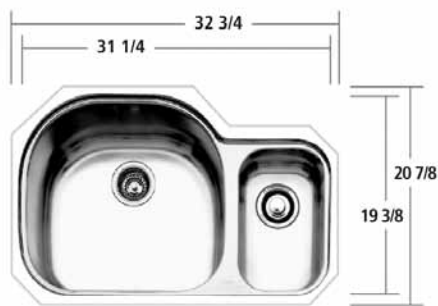

LIST PRICE
\$980

36

OVERALL DIMENSIONS	32 3/4 x 20 7/8"	830 x 530mm
SUPER BASIN	20 x 18 x 10"	510 x 456 x 240mm
MINI BASIN	8 1/2 x 13 3/4 x 6"	215 x 350 x 150mm
MINIMUM CABINET WIDTH	36"	92cm
INCLUDED ACCESSORIES		



AC09



AC80

83U Essentials series

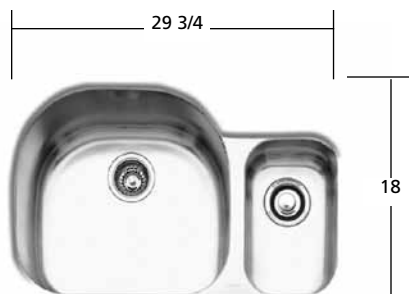

LIST PRICE
\$696

33

OVERALL DIMENSIONS	29 3/4 x 18"	745 x 457mm
LARGE BASIN	20 x 18 x 9 1/2"	508 x 457 x 241mm
SMALL BASIN	8 1/2 x 13 x 5 1/2"	215 x 330 x 140mm
MINIMUM CABINET WIDTH	33"	84cm
OPTIONAL ACCESSORIES		



AC09-\$38



AC80-\$166

800 series and Essentials undermounts



18
GAUGE

36 Cabinet Space
This icon indicates minimum cabinet space (inches) for the sink base unit to accommodate basins (e.g. 36 = 36 inches)

Essentials series have sound deadening pads but do not have undercoating or accessories included. Some configurations have shallower bowl depths compared to the regular 800 series equivalent.

884U

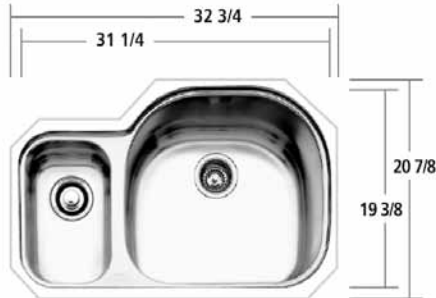

LIST PRICE
\$980

36

OVERALL DIMENSIONS	32 3/4 x 20 7/8"	830 x 530mm
SUPER BASIN	20 x 18 x 10"	510 x 456 x 240mm
MINI BASIN	8 1/2 x 13 3/4 x 6"	215 x 350 x 150mm
MINIMUM CABINET WIDTH	36"	92cm

INCLUDED ACCESSORIES

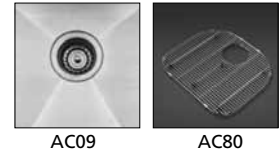

84U Essentials series

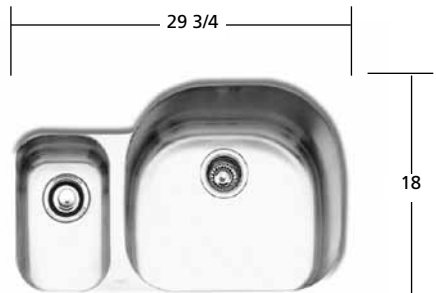

LIST PRICE
\$696

33

OVERALL DIMENSIONS	29 3/4 x 18"	745 x 457mm
LARGE BASIN	20 x 18 x 9 1/2"	508 x 457 x 241mm
SMALL BASIN	8 1/2 x 13 x 5 1/2"	215 x 330 x 140mm
MINIMUM CABINET WIDTH	33"	84cm

OPTIONAL ACCESSORIES

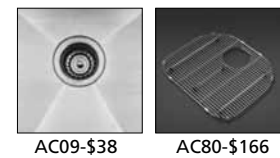

885U

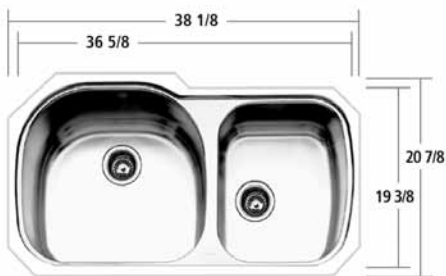

LIST PRICE
\$1120

39

OVERALL DIMENSIONS	38 1/8 x 20 7/8"	970 x 530mm
SUPER BASIN	20 x 18 x 10"	510 x 456 x 240mm
MAXI BASIN 1	13 3/4 x 16 1/2 x 8"	350 x 420 x 203mm
MINIMUM CABINET WIDTH	39"	100cm

INCLUDED ACCESSORIES

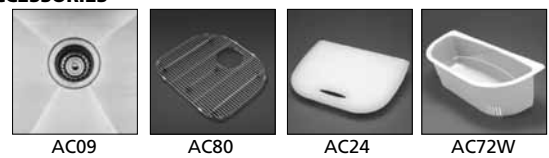

886U

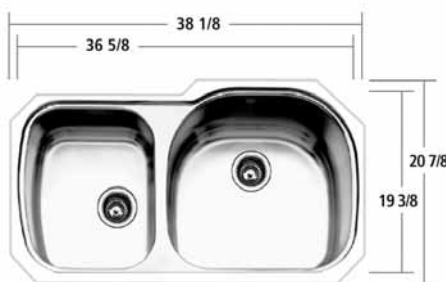

LIST PRICE
\$1120

39

OPTIONAL ACCESSORIES

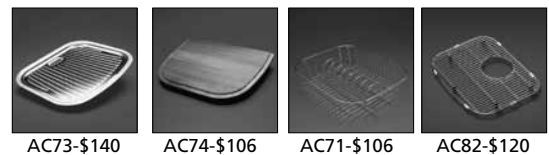

800 series and Essentials undermounts



18
GAUGE

36 Cabinet Space
This icon indicates minimum cabinet space (inches) for the sink base unit to accommodate basins (e.g. 36 = 36 inches)

Essentials series have sound deadening pads but do not have undercoating or accessories included. Some configurations have shallower bowl depths compared to the regular 800 series equivalent.

890U



LIST PRICE
\$876

33

OVERALL DIMENSIONS	30 x 18 x 9 1/2"	760 x 450 x 240mm
TITAN BASIN	28 x 16 x 9 1/2"	710 x 400 x 240mm
MINIMUM CABINET WIDTH	33"	84cm
INCLUDED ACCESSORIES		



AC09



AC89

90U Essentials series



LIST PRICE
\$592

33

OVERALL DIMENSIONS	28 x 16"	711 x 406mm
LARGE BASIN	28 x 16"	711 x 406mm
MINIMUM CABINET WIDTH	33"	84cm
INCLUDED ACCESSORIES		

OPTIONAL ACCESSORIES



AC09-\$38



AC89-\$212

893U

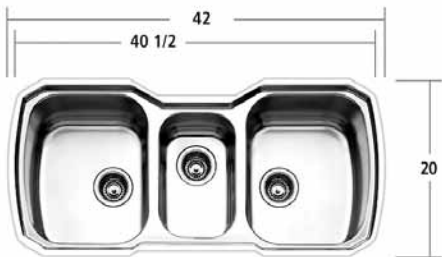

LIST PRICE
\$1116

42

OVERALL DIMENSIONS	42 x 20"	1065 x 505mm
MAXI BASIN 1	13 3/4 x 16 1/2 x 8"	350 x 420 x 203mm
MINI BASIN	8 1/2 x 13 3/4 x 6"	215 x 350 x 150mm
MINIMUM CABINET WIDTH	42"	106cm
INCLUDED ACCESSORIES		



AC09 x 2

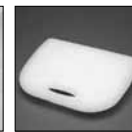

AC24



AC72 W

OPTIONAL ACCESSORIES



AC73-\$140



AC74-\$106



AC71-\$106

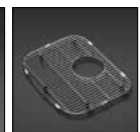

AC82-\$120

800 series topmounts



18
GAUGE

36
Cabinet Space
This icon indicates minimum cabinet space (inches) for the sink base unit to accommodate basins (e.g. 36 = 36 inches)

1 NUMBER OF FAUCET HOLES
0 NO FAUCET TAPPINGS (LOCATE FAUCET BEHIND SINK)
REFER TO FAUCET TAPPING HOLE MANUAL FOR TAPPING OPTIONS

833-1

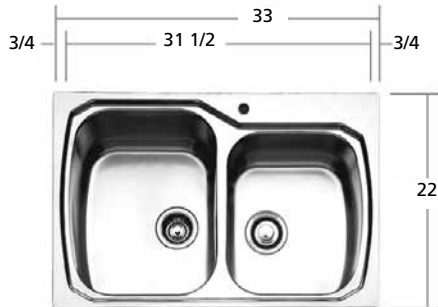

LIST PRICE
\$859

33

OVERALL DIMENSIONS	33 x 22"	840 x 560mm
GOURMET BASIN	14 3/4 x 19 x 10"	375 x 483 x 254mm
MAXI BASIN 1	13 3/4 x 16 1/2 x 8"	350 x 420 x 203mm
MINIMUM CABINET WIDTH	33"	84cm
OPTIONAL TAPPING HOLE	1, 2, 3 or 4 (4" CC)	

INCLUDED ACCESSORIES

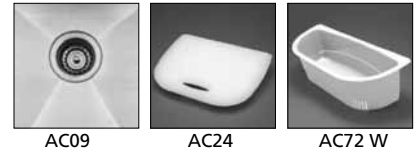

834-1

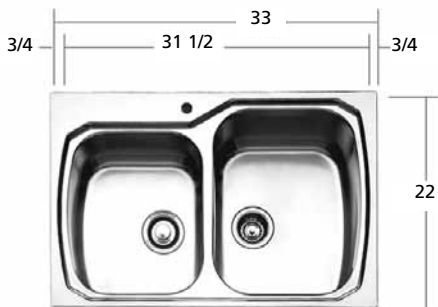

LIST PRICE
\$859

33

OPTIONAL ACCESSORIES

AC73-\$140	AC74-\$106	AC71-\$106	AC81-\$144	AC82-\$120

863-1

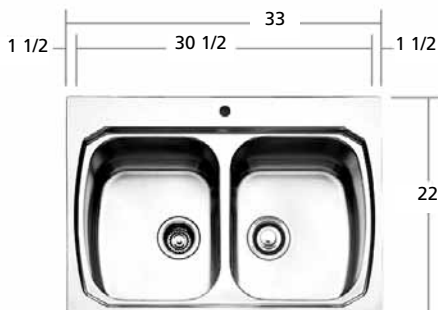

LIST PRICE
\$715

33

OVERALL DIMENSIONS	33 x 22"	840 x 560mm
MAXI BASIN 1	13 3/4 x 16 1/2 x 8"	350 x 420 x 203mm
MINIMUM CABINET WIDTH	33"	84cm
OPTIONAL TAPPING HOLE	1, 2, 3, 4 or 5 (4" CC)	

INCLUDED ACCESSORIES

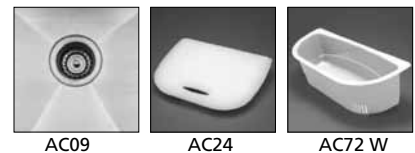

OPTIONAL ACCESSORIES

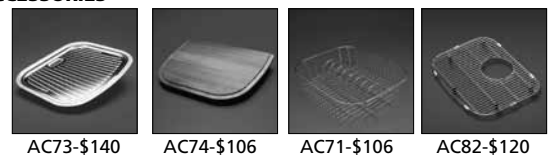

800 series topmounts



36 **Cabinet Space**
 This icon indicates minimum cabinet space (inches) for the sink base unit to accommodate basins (e.g. 36 = 36 inches)

1 NUMBER OF FAUCET HOLES
 0 NO FAUCET TAPPINGS (LOCATE FAUCET BEHIND SINK)
 REFER TO FAUCET TAPPING HOLE MANUAL FOR TAPPING OPTIONS

886-1

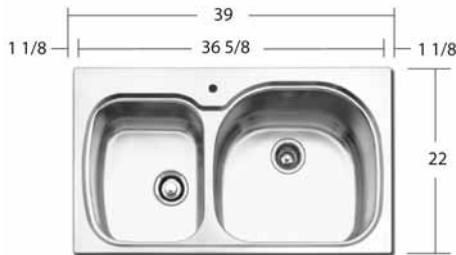

LIST PRICE
\$1120

39

OVERALL DIMENSIONS	39 x 22"	1065 x 560mm
SUPER BASIN	20 x 18 x 10"	508 x 450 x 254mm
MAXI BASIN 1	13 3/4 x 16 1/2 x 8"	349 x 420 x 203mm
MINIMUM CABINET WIDTH	39"	100cm
OPTIONAL TAPPING HOLE	1, 2, 3, 4, 5 or 6 (4" CC)	

INCLUDED ACCESSORIES

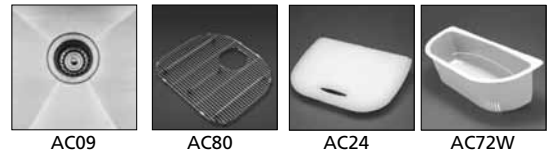

OPTIONAL ACCESSORIES

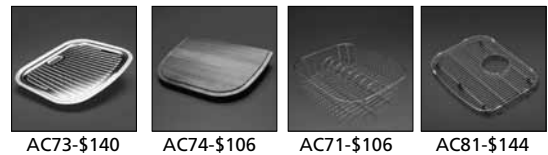

893-1

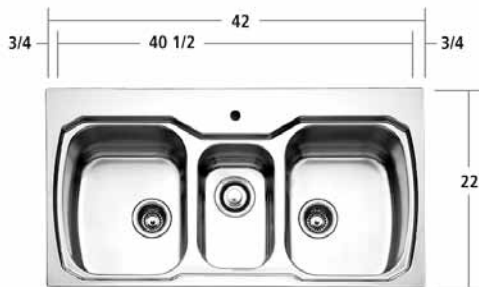

LIST PRICE
\$1116

42

OVERALL DIMENSIONS	42 x 22"	1065 x 560mm
MAXI BASIN 1	13 3/4 x 16 1/2 x 8"	350 x 420 x 203mm
MINI BASIN	8 1/2 x 13 3/4 x 6"	215 x 350 x 150mm
MINIMUM CABINET WIDTH	42"	106cm
OPTIONAL TAPPING HOLE	1, 2, 3, 4, or 5 (4" CC)	

INCLUDED ACCESSORIES

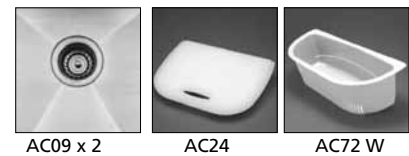

OPTIONAL ACCESSORIES

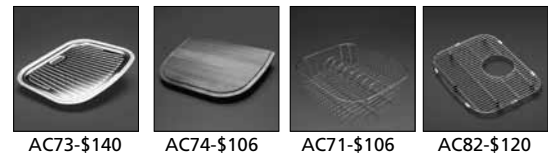

Apron series



36 **Cabinet Space**
This icon indicates minimum cabinet space (inches) for the sink base unit to accommodate basins (e.g. 36 = 36 inches)

1263U



LIST PRICE
\$2176

36

OVERALL DIMENSIONS	33 x 21"	838 x 533mm
STANDARD BASIN	14 x 17 x 9"	356 x 432 x 229mm
MINIMUM CABINET WIDTH	36"	92cm
INCLUDED ACCESSORIES		



AC09

1283U



LIST PRICE
\$2075

30

OVERALL DIMENSIONS	27 x 21"	686 x 533mm
STANDARD BASIN	14 x 17 x 9"	356 x 432 x 229mm
1/2 BASIN 2	9 x 17 x 9"	229 x 432 x 229mm
MINIMUM CABINET WIDTH	30"	76cm
INCLUDED ACCESSORIES		



AC09

1290U

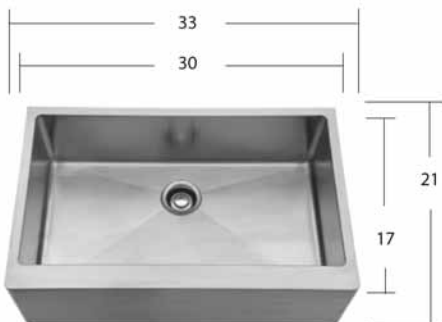

LIST PRICE
\$1546

36

OVERALL DIMENSIONS	33 x 21"	838 x 533mm
LARGE BASIN 2	30 x 17 x 10"	762 x 432 x 254mm
MINIMUM CABINET WIDTH	36"	92cm
INCLUDED ACCESSORIES		



AC09

Apron series Fireclay



36 **Cabinet Space**
This icon indicates minimum cabinet space (inches) for the sink base unit to accommodate basins (e.g. 36 = 36 inches)

2280FC

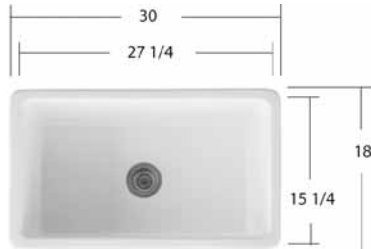

LIST PRICE
\$1200

33

OVERALL DIMENSIONS	30 x 18"	762 x 457mm
MEGA BASIN 2	27 1/4 x 15 1/4 x 8 3/4"	692 x 387 x 222mm
MINIMUM CABINET WIDTH	33"	84cm
INCLUDED ACCESSORIES		



AC09

2290FC

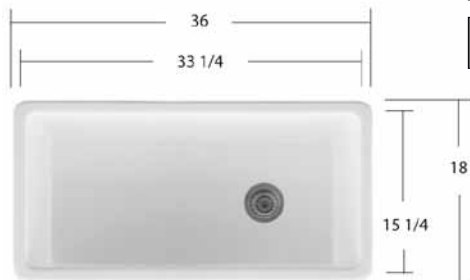

LIST PRICE
\$1495

39

OVERALL DIMENSIONS	36 x 18"	914 x 457mm
TITAN BASIN 3	33 1/4 x 15 1/4 x 8 3/4"	845 x 387 x 222mm
MINIMUM CABINET WIDTH	39"	100cm
INCLUDED ACCESSORIES		



AC09

2286FC

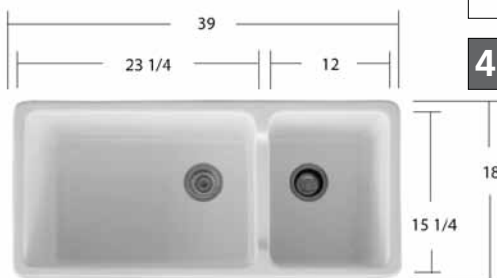

LIST PRICE
\$2608

42

OVERALL DIMENSIONS	39 x 20"	991 x 508mm
MAXI BASIN 4	23 1/4 x 15 3/4 x 9"	591 x 400 x 229mm
3/4 BASIN 2	12 x 15 3/4 x 9"	305 x 400 x 229mm
MINIMUM CABINET WIDTH	42"	106cm
INCLUDED ACCESSORIES		



AC09

Drainboard series



20
GAUGE

36
Cabinet Space
This icon indicates minimum cabinet space (inches) for the sink base unit to accommodate basins (e.g. 36 = 36 inches)

220-0

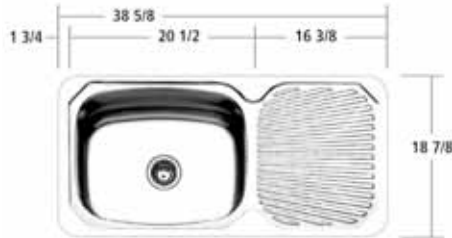

LIST PRICE
\$787

24

OVERALL DIMENSIONS	38 5/8 x 18 7/8"	980 x 480mm
MEGA BASIN 1	20 1/2 x 15 3/4 x 7 3/4"	520 x 400 x 197mm
MINIMUM CABINET WIDTH	24"	61cm
INCLUDED ACCESSORIES		



AC09

221-1

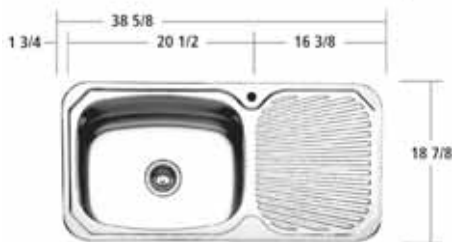

LIST PRICE
\$787

24

OVERALL DIMENSIONS	38 5/8 x 18 7/8"	980 x 480mm
MEGA BASIN 1	20 1/2 x 15 3/4 x 7 3/4"	520 x 400 x 197mm
MINIMUM CABINET WIDTH	24"	61cm
OPTIONAL TAPPING HOLE	1	
INCLUDED ACCESSORIES		



AC09

222-1

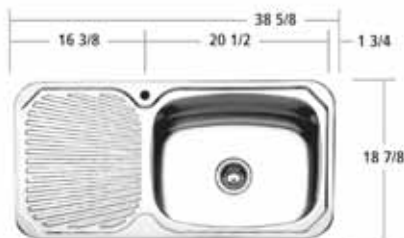

LIST PRICE
\$787

24

OVERALL DIMENSIONS	38 5/8 x 18 7/8"	980 x 480mm
MEGA BASIN 1	20 1/2 x 15 3/4 x 7 3/4"	520 x 400 x 197mm
MINIMUM CABINET WIDTH	24"	61cm
OPTIONAL TAPPING HOLE	1	
INCLUDED ACCESSORIES		



AC09

Drainboard series



18
GAUGE

36 Cabinet Space
This icon indicates minimum cabinet space (inches) for the sink base unit to accommodate basins (e.g. 36 = 36 inches)

273-1

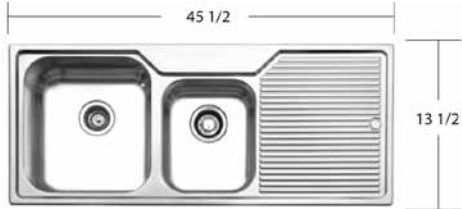

LIST PRICE
\$874

33

OVERALL DIMENSIONS	45 1/4 x 20"	1149 x 508mm
GENEROUS BASIN	15 x 16 1/2 x 8"	381 x 419 x 203mm
MIDI BASIN 1	11 x 13 3/4 x 8"	279 x 349 x 203mm
MINIMUM CABINET WIDTH	33"	84cm

INCLUDED ACCESSORIES



AC09



AC62

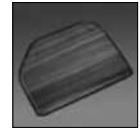

AC65

274-1

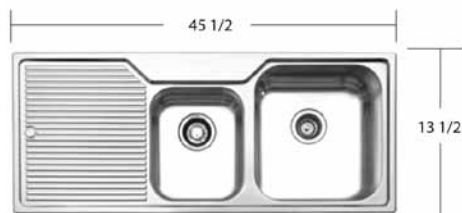

LIST PRICE
\$874

33

882U

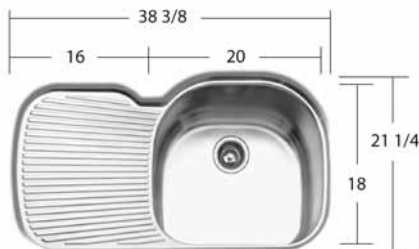

LIST PRICE
\$870

24

OVERALL DIMENSIONS	38 3/8 x 21 1/4"	974 x 540mm
SUPER BASIN	20 x 18 x 10"	508 x 457 x 257mm
MINIMUM CABINET WIDTH	24"	61cm

INCLUDED ACCESSORIES



AC09



AC80

882-1

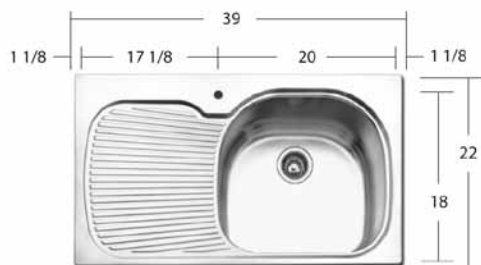

LIST PRICE
\$870

24

OVERALL DIMENSIONS	38 3/8 x 21 1/4"	974 x 540mm
SUPER BASIN	20 x 18 x 10"	508 x 457 x 257mm
MINIMUM CABINET WIDTH	24"	61cm
OPTIONAL TAPPING HOLE	1	

INCLUDED ACCESSORIES



AC09



AC80

Compact series



18
GAUGE

36 Cabinet Space
This icon indicates minimum cabinet space (inches) for the sink base unit to accommodate basins (e.g. 36 = 36 inches)

70U

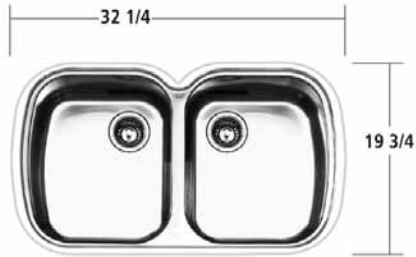

LIST PRICE
\$558

36

OVERALL DIMENSIONS	32 1/4 x 19 3/4"	820 x 500mm
MAXI BASIN 2	13 3/4 x 16 1/2 x 7 3/4"	350 x 420 x 190mm
MINIMUM CABINET WIDTH	36"	92cm

INCLUDED ACCESSORIES

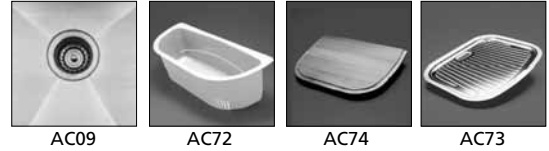

OPTIONAL ACCESSORIES

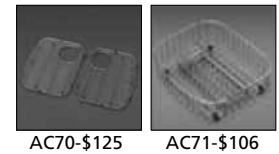

71U

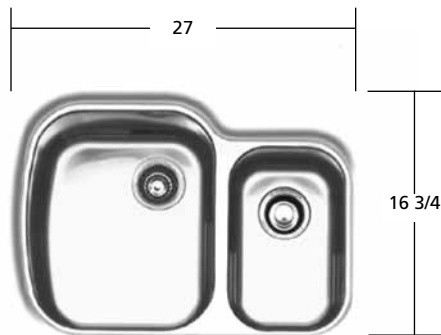

LIST PRICE
\$458

30

OVERALL DIMENSIONS	27 x 16 3/4"	686 x 425mm
MAXI BASIN 2	15 x 13 3/4 x 7"	381 x 349 x 178mm
MINI BASIN	13 x 8 3/4 x 5"	330 x 222 x 127mm
MINIMUM CABINET WIDTH	30"	76cm

INCLUDED ACCESSORIES

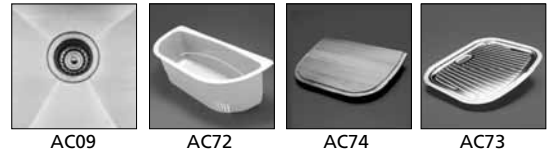

OPTIONAL ACCESSORIES

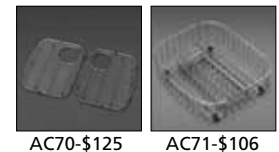

72U

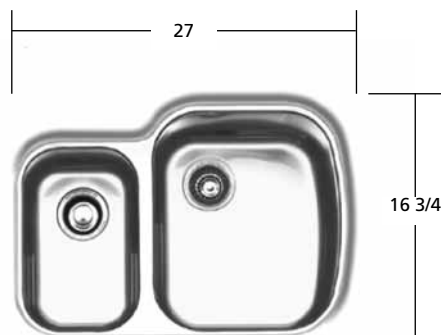

LIST PRICE
\$458

30

OVERALL DIMENSIONS	27 x 16 3/4"	686 x 425mm
MAXI BASIN	15 x 13 3/4 x 7"	381 x 349 x 178mm
MINI BASIN	13 x 8 3/4 x 5"	330 x 222 x 127mm
MINIMUM CABINET WIDTH	30"	76cm

INCLUDED ACCESSORIES

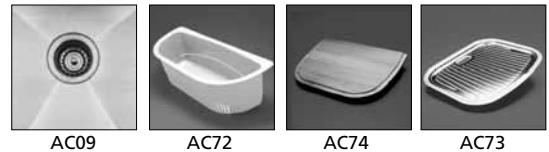

OPTIONAL ACCESSORIES

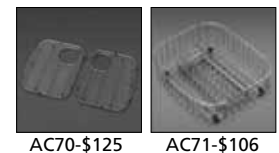

Compact series



18
GAUGE

36
Cabinet Space
This icon indicates minimum cabinet space (inches) for the sink base unit to accommodate basins (e.g. 36 = 36 inches)

200-1

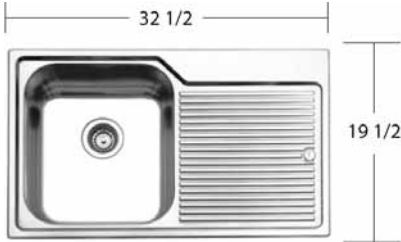

LIST PRICE
\$639

21

OVERALL DIMENSIONS	32 1/2 x 19 1/2"	825 x 495mm
GENEROUS BASIN	15 x 16 1/2 x 8"	381 x 419 x 203mm
MINIMUM CABINET WIDTH	21"	53cm

INCLUDED ACCESSORIES



AC09



AC62

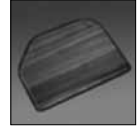

AC65

201-1

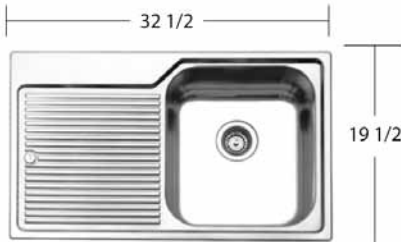

LIST PRICE
\$639

21

OVERALL DIMENSIONS	32 1/2 x 19 1/2"	825 x 495mm
GENEROUS BASIN	15 x 16 1/2 x 8"	381 x 419 x 203mm
MINIMUM CABINET WIDTH	21"	53cm

INCLUDED ACCESSORIES



AC09



AC62

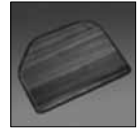

AC65

Preparation bar series



36
Cabinet Space
 This icon indicates minimum cabinet space (inches) for the sink base unit to accommodate basins (e.g. 36 = 36 inches)

190-1

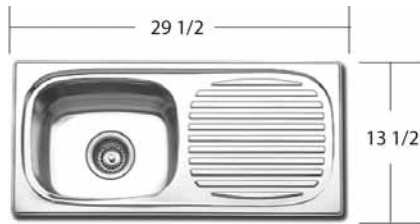

LIST PRICE
\$458

18

OVERALL DIMENSIONS	29 1/2 x 13 1/2"	749 x 343mm
MIDI BASIN 2	13 x 10 1/2 x 5 1/2"	330 x 267 x 140mm
MINIMUM CABINET WIDTH	18"	46cm
INCLUDED ACCESSORIES		



AC09



AC02

191-1

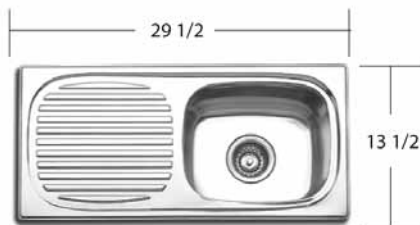

LIST PRICE
\$458

18

OVERALL DIMENSIONS	29 1/2 x 13 1/2"	749 x 343mm
MIDI BASIN 2	13 x 10 1/2 x 5 1/2"	330 x 267 x 140mm
MINIMUM CABINET WIDTH	18"	46cm
INCLUDED ACCESSORIES		



AC09



AC02

410-0

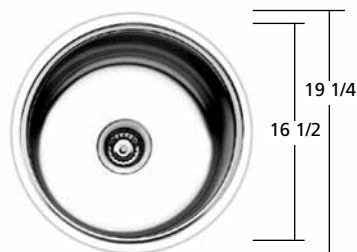

LIST PRICE
\$405

21

OVERALL DIMENSIONS	19 1/4 x 7"	490 x 180mm
ROUND BASIN	16 1/2 x 7"	420 x 180mm
MINIMUM CABINET WIDTH	21"	53cm
INCLUDED ACCESSORIES		



AC09

OPTIONAL ACCESSORIES



AC50-\$118



AC51-\$118



AC53-\$140

Preparation bar series



36 Cabinet Space
This icon indicates minimum cabinet space (inches) for the sink base unit to accommodate basins (e.g. 36 = 36 inches)

430U



LIST PRICE
\$336

18

OVERALL DIMENSIONS	14 x 16"	355 x 405mm
MAXI BASIN 3	13 x 15 x 7 3/4"	330 x 385 x 198mm
MINIMUM CABINET WIDTH	18"	46cm
INCLUDED ACCESSORIES		



AC09

OPTIONAL ACCESSORIES



AC03-\$99

450U



LIST PRICE
\$318

18

OVERALL DIMENSIONS	15 x 17 3/4"	308 x 450mm
MAXI BASIN 1	13 3/4 x 16 1/2 x 8"	350 x 420 x 203mm
MINIMUM CABINET WIDTH	18"	46cm
INCLUDED ACCESSORIES		



AC09

OPTIONAL ACCESSORIES



AC24-\$106

AC71-\$106

AC73-\$140

AC74-\$106

AC82-\$120

480-1

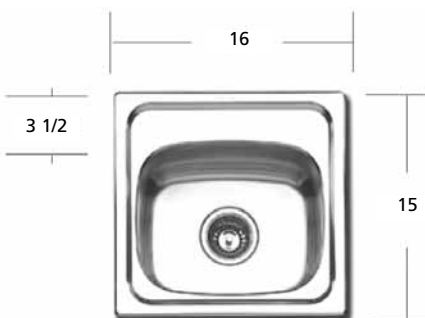

LIST PRICE
\$366

18

OVERALL DIMENSIONS	16 1/8 x 15 3/4"	410 x 400mm
MIDI BASIN 2	10 1/2 x 13 x 6 1/2"	270 x 330 x 163mm
MINIMUM CABINET WIDTH	18"	46cm
OPTIONAL TAPPING HOLE	1, 2 or 3 (480-1C Illustrated)	
INCLUDED ACCESSORIES		



AC09

Preparation bar series



18
GAUGE

36 Cabinet Space
This icon indicates minimum cabinet space (inches) for the sink base unit to accommodate basins (e.g. 36 = 36 inches)

485U

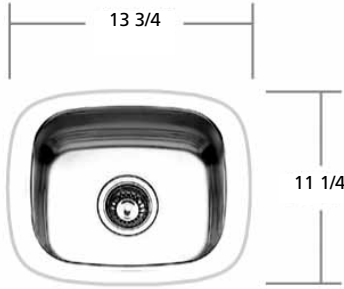

LIST PRICE
\$281

15

OVERALL DIMENSIONS	11 1/4 x 13 3/4"	285 x 349mm
MIDI BASIN 2	10 1/2 x 13 x 6 1/2"	270 x 330 x 163mm
MINIMUM CABINET WIDTH	15"	38cm

INCLUDED ACCESSORIES



AC09

OPTIONAL ACCESSORIES



AC03-\$99

650U

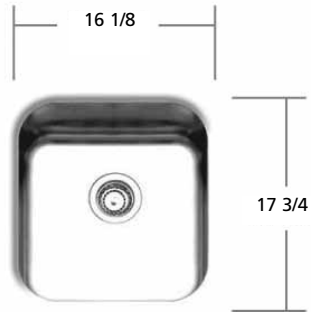

LIST PRICE
\$305

18

OVERALL DIMENSIONS	16 1/8 x 17 3/4"	409 x 480mm
GENEROUS BASIN	15 x 15 3/4 x 8"	381 x 400 x 203mm
MINIMUM CABINET WIDTH	18"	46cm

INCLUDED ACCESSORIES



AC09

OPTIONAL ACCESSORIES



AC61-\$108



AC62-\$58



AC63-\$160

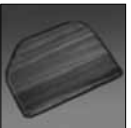

AC65-\$116

Laundry series

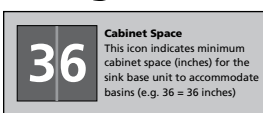

410

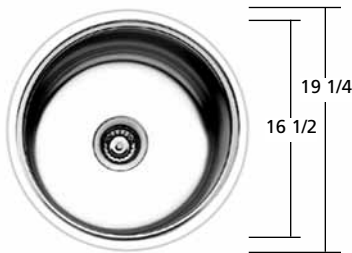

LIST PRICE
\$405

21

OVERALL DIMENSIONS	19 1/4 x 7"	490 x 180mm
ROUND BASIN	16 1/2 x 7"	420 x 180mm
MINIMUM CABINET WIDTH	21"	53cm
INCLUDED ACCESSORIES		



AC09

OPTIONAL ACCESSORIES



AC50-\$118

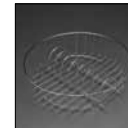

AC51-\$118



AC53-\$140

470-1



LIST PRICE
\$608

24

OVERALL DIMENSIONS	24 3/4 x 21 1/2"	630 x 550mm
GRANDE BASIN	22 x 18 3/4 x 12 1/2"	560 x 480 x 313mm
MINIMUM CABINET WIDTH	24"	61cm
OPTIONAL TAPPING HOLE	1 or 2, left or right ledge (470-1L Illustrated)	
INCLUDED ACCESSORIES		



AC09

490U

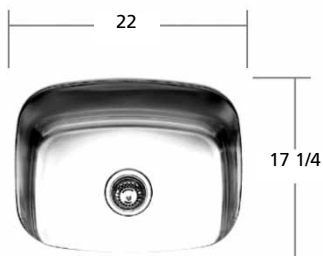

LIST PRICE
\$578

24

OVERALL DIMENSIONS	22 x 17 1/4"	560 x 440mm
MEGA BASIN 2	20 1/2 x 15 3/4 x 9 1/2"	520 x 400 x 241mm
MINIMUM CABINET WIDTH	24"	61cm
INCLUDED ACCESSORIES		



AC09

Laundry series



18
GAUGE

36
Cabinet Space
This icon indicates minimum cabinet space (inches) for the sink base unit to accommodate basins (e.g. 36 = 36 inches)

882U



LIST PRICE
\$870

24

OVERALL DIMENSIONS	38 3/8 x 21 1/4"	974 x 540mm
SUPER BASIN	20 x 18 x 10"	508 x 457 x 257mm
MINIMUM CABINET WIDTH	24"	61cm
INCLUDED ACCESSORIES		



AC09



AC80

882-1

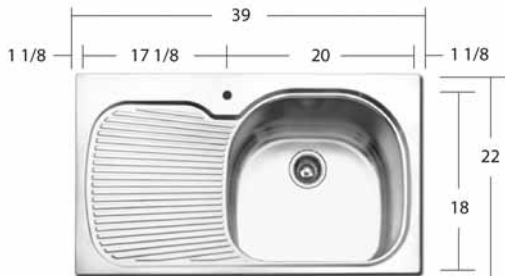

LIST PRICE
\$870

24

OVERALL DIMENSIONS	39 x 22"	990 x 559mm
SUPER BASIN	20 x 18 x 10"	508 x 457 x 257mm
MINIMUM CABINET WIDTH	24"	61cm
OPTIONAL TAPPING HOLE	1 or 2, left or right ledge (882-1C Illustrated)	
INCLUDED ACCESSORIES		



AC09



AC80



If it's not an Oliveri, it's a Compromise.

Parts and Accessories



AC03 \$99
STAINLESS STEEL DRAINER BASKET & RACK
FOR 220, 300, 400, 430 (Maxi Basin 3 & 4)



AC09 \$38
1 x BASKETWASTE 1 1/2



AC24 \$106
WHITE SYNTHETIC CUTTING BOARD
FOR 700 AND 800 SERIES SINKS (Maxi Basin 3 & 4)



AC50 \$118
HARDWOOD CUTTING BOARD
FOR 410 SINKS (Round Basin)

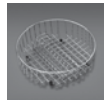

AC51 \$118
STAINLESS STEEL DRAINER BASKET & RACK
FOR 410 SINKS (Round Basin 3)



AC53 \$140
STAINLESS STEEL DRAINER TRAY
FOR THE 410 SERIES SINKS (Round Basin)



AC61 \$108
STAINLESS STEEL DISH BASKET FOR
THE GENEROUS BASIN



AC62 \$58
GREY COLANDER FOR THE GENEROUS BASIN



AC63 \$160
STAINLESS STEEL DRAIN TRAY
FOR THE GENEROUS BASIN

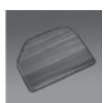

AC65 \$116
3/4" HARDWOOD CUTTING BOARD
FOR THE GENEROUS BASIN



AC70 \$125
STAINLESS STEEL BASIN PROTECTOR
FOR 70U SERIES SINKS (Double Basin)



AC71 \$106
STAINLESS STEEL DRAINER BASKET & RACK FOR 700 & 800
SERIES SINKS AND 450U EXCLUDING 883U, 884U, 880U
(Main Basin 3 & 4)



AC72 \$62
"D" SHAPED COLANDER FOR 700 SERIES SINKS AND 450U
EXCLUDING 883U, 884U, 880U (Maxi Basin 1 & 2)



AC73 \$140
STAINLESS STEEL DRAINER TRAY FOR 700 AND 800 SERIES SINKS
AND 450U EXCLUDING 883U, 884U, 880U (Maxi Basin 1 & 2)

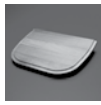

AC74 \$106
HARDWOOD CUTTING BOARD FOR 700 SERIES SINKS
AND 450U EXCLUDING 883U, 884U, 880U (Maxi Basin 1 & 2)

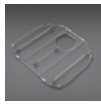

AC80 \$166
STAINLESS STEEL BASIN PROTECTOR
FOR 880 SERIES SINKS (Super Basin)

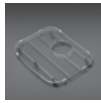

AC81 \$144
STAINLESS STEEL BASIN PROTECTOR
FOR 870 & 830 SERIES SINKS (Gourmet Basin)

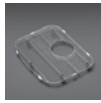

AC82 \$120
STAINLESS STEEL BASIN PROTECTOR FOR 800 & 450 SERIES
SINKS EXCLUDING 883U, 884U AND 880U (Maxi Basin 1)

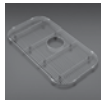

AC89 \$212
STAINLESS STEEL BASIN PROTECTOR
FOR 89 & 890 SERIES SINKS (Titan Basin 1)

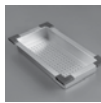

ACP112 \$138
STAINLESS STEEL COLANDER
FOR 1163U, 1173U, 1183U, 1150U AND 1190U SINKS



ACP113 \$68
STAINLESS STEEL BASIN PROTECTOR FOR 3/4 BASIN
FOR 1130U AND 1173U SINKS

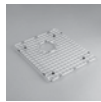

ACP114 \$98
STAINLESS STEEL BASIN PROTECTOR FOR STANDARD BASIN
FOR 1140U SINK

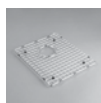

ACP115 \$88
STAINLESS STEEL BASIN PROTECTOR FOR STANDARD BASIN
FOR 1150U, 1183U, 1163U AND 1173U SINKS



ACP116 \$58
STAINLESS STEEL BASIN PROTECTOR FOR 1/2 BASIN
FOR 1160U AND 1183U SINKS



ACP119 \$102
STAINLESS STEEL BASIN PROTECTOR FOR TITAN BASIN 2
FOR 1190U SINK

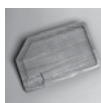

ACP126 \$116
WOOD TIMBRE PREP BOARD
FOR 1173U AND 1130U SINKS

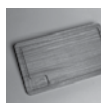

ACP128 \$122
WOOD TIMBRE PREP BOARD
FOR 1163U, 1173U, 1183U, 1190U AND 1150U SINKS

CL \$14
TOPMOUNT INSTALLATION CUP ASSEMBLY (4 PER SET)

CLU \$14
DOWN-UNDERMOUNT INSTALLATION CLIPS, SCREWS,
& MOLLEYS (4 PER SET)

Product Index



PRODUCT	PRICE	PAGE
63U	\$598	7
70U	\$558	18
71U	\$458	18
72U	\$458	18
73U	\$692	8
74U	\$692	8
80U	\$358	9
83U	\$696	9
84U	\$696	10
90U	\$592	11
190-1	\$458	20
191-1	\$458	20
200-1	\$639	19
201-1	\$639	19
220-0	\$787	16
221-1	\$787	16
222-1	\$787	16
273-1	\$874	17
274-1	\$874	17
410	\$806	23
410-0	\$405	20
430U	\$336	21
450U	\$318	21
470-1	\$608	23
480-1	\$366	21
485U	\$281	22
490U	\$578	23
650U	\$305	22
833-1	\$859	12
833U	\$976	7
834-1	\$859	12
834U	\$976	7
863-1	\$715	12
863U	\$899	7
873U	\$976	8
874U	\$976	8
880U	\$625	9
882-1	\$870	17
882U	\$870	17
883U	\$980	9
884U	\$980	10
885U	\$1120	10
886-1	\$1120	13
886U	\$1120	10
890U	\$876	11
893-1	\$1116	13
893U	\$1116	11

PRODUCT	PRICE	PAGE
1130U	\$806	4
1140U	\$906	4
1150U	\$876	4
1160U	\$786	5
1163U	\$1898	5
1173U	\$1865	5
1183U	\$1875	6
1190U	\$1246	6
1283U	\$2075	14
1263U	\$2176	14
1290U	\$1546	14
2280FC	\$1200	15
2290FC	\$1495	15
2286FC	\$2608	15

ACCESSORIES & OPTIONS

AC 03	\$99	26
AC 09	\$38	26
AC 24	\$106	26
AC 50	\$118	26
AC 51	\$118	26
AC 53	\$140	26
AC 61	\$108	26
AC 62	\$58	26
AC 63	\$160	26
AC 65	\$116	26
AC 70	\$125	26
AC 71	\$106	26
AC 72	\$62	26
AC 73	\$140	26
AC 74	\$106	26
AC 80	\$166	26
AC 81	\$144	26
AC 82	\$120	26
AC 89	\$212	26
ACP112	\$138	26
ACP113	\$68	26
ACP114	\$88	26
ACP115	\$88	26
ACP116	\$58	26
ACP119	\$102	26
ACP126	\$116	26
ACP128	\$122	26
CL	\$14	26
CLU	\$14	26



www.oliverisinks.com

The company began life as a general and domestic metal fabricator in 1947. The founders pioneered the deep drawing technology in Australia, creating seamless, deep drawn stainless steel basins. A multi-million dollar upgrade in 1994 saw the production facility move to new 66,000 square feet premises and the installation of the latest high-tech machinery sourced from around the world.

The introduction of new equipment has allowed Tasman Sinkware to produce their sinks to 'world standard' best practice. Tasman Sinkware is a Quality Endorsed company and all products are manufactured to Standard ISO 9002, and sinks have "UPC" (Uniform Plumbing Code) approvals. They reflect modern and innovative styles that are crafted to suit even the most discerning homeowner.

Tasman Sinkware is proud of its hard-earned reputation as a premium quality and market-leading designer and manufacturer of kitchen products. Tasman Sinkware will continue to develop designs and styles suitable for any application where the highest standards are demanded.

DISTRIBUTED BY

Tasman Sinkware North America Inc., 1230 Railroad Street, Corona, CA 92882 1-800-449-4401 Email: northamerica@oliverisinks.com

MANUFACTURED BY



PLEASE TAKE A MOMENT TO FAMILIARIZE YOURSELF WITH THE TASMAN SINKWARE NORTH AMERICA WARRANTY, ITS BENEFITS, AND LIMITATIONS.

TASMAN SINKWARE DISTRIBUTORS SUPPORT YOU WITH COMPANY TRAINED TECHNICAL SPECIALISTS EXPERIENCED IN THE PRODUCTION, INSTALLATION, AND CARE OF OLIVERI BRAND SINKS AND ACCESSORIES.

HERE IS WHAT YOU NEED TO DO IF YOU REQUIRE SERVICE:

FIRST: CONTACT THE KITCHEN DEALER OR CONTRACTOR WHO SOLD AND/OR INSTALLED THE PRODUCT. THEY SHOULD BE ABLE TO SOLVE ANY PROBLEMS YOU MAY HAVE.

SECOND: IF YOUR DEALER OR CONTRACTOR CAN NOT SOLVE THE PROBLEM, THEY WILL CONTACT OR SUPPLY YOU WITH THE NAME OF THE TASMAN SINKWARE DISTRIBUTOR/AGENT WHO SUPPLIED THE PRODUCT AND THE NAME OF THEIR OLIVERI TECHNICAL SPECIALIST.

THIRD: IF YOU ARE UNABLE TO OBTAIN WARRANTY SERVICE THROUGH EITHER YOUR CONTRACTOR OR THE TASMAN SINKWARE DISTRIBUTOR/AGENT, PLEASE WRITE TO TASMAN SINKWARE US OFFICE.

FOURTH: INCLUDE ALL PERTINENT INFORMATION REGARDING YOUR CLAIM, INCLUDING A COMPLETE DESCRIPTION OF THE PRODUCT, MODEL NUMBERS, AND DATE THE PRODUCT

WAS INSTALLED. MOST OF THIS INFORMATION IS ON THE IDENTIFICATION LABEL LOCATED ON THE UNDERSIDE OF THE BASIN. ALSO PROVIDE US THE NAME OF THE INSTALLING CONTRACTOR AND DISTRIBUTOR

UNDER ITS POLICY OF ONGOING PRODUCT DEVELOPMENT TASMAN SINKWARE MAY FROM TIME TO TIME CHANGE PRODUCT SPECIFICATION WITHOUT NOTICE. WARNING: PRODUCTS IN THIS BROCHURE AND ALL LITERATURE PERTAINING TO, ARE SUBJECT TO INTELLECTUAL PROPERTY PROTECTION. ALL DIMENSIONS GIVEN ARE APPROXIMATE AND SHOULD BE CHECKED PRIOR TO INSTALLATION. PRODUCT COLOR REPRODUCTION IS AS NEAR TO ACTUAL AS PRINTING METHODS ALLOW.